

45062_NB

AVAILABLE FINISHES:

C, D, G, PW

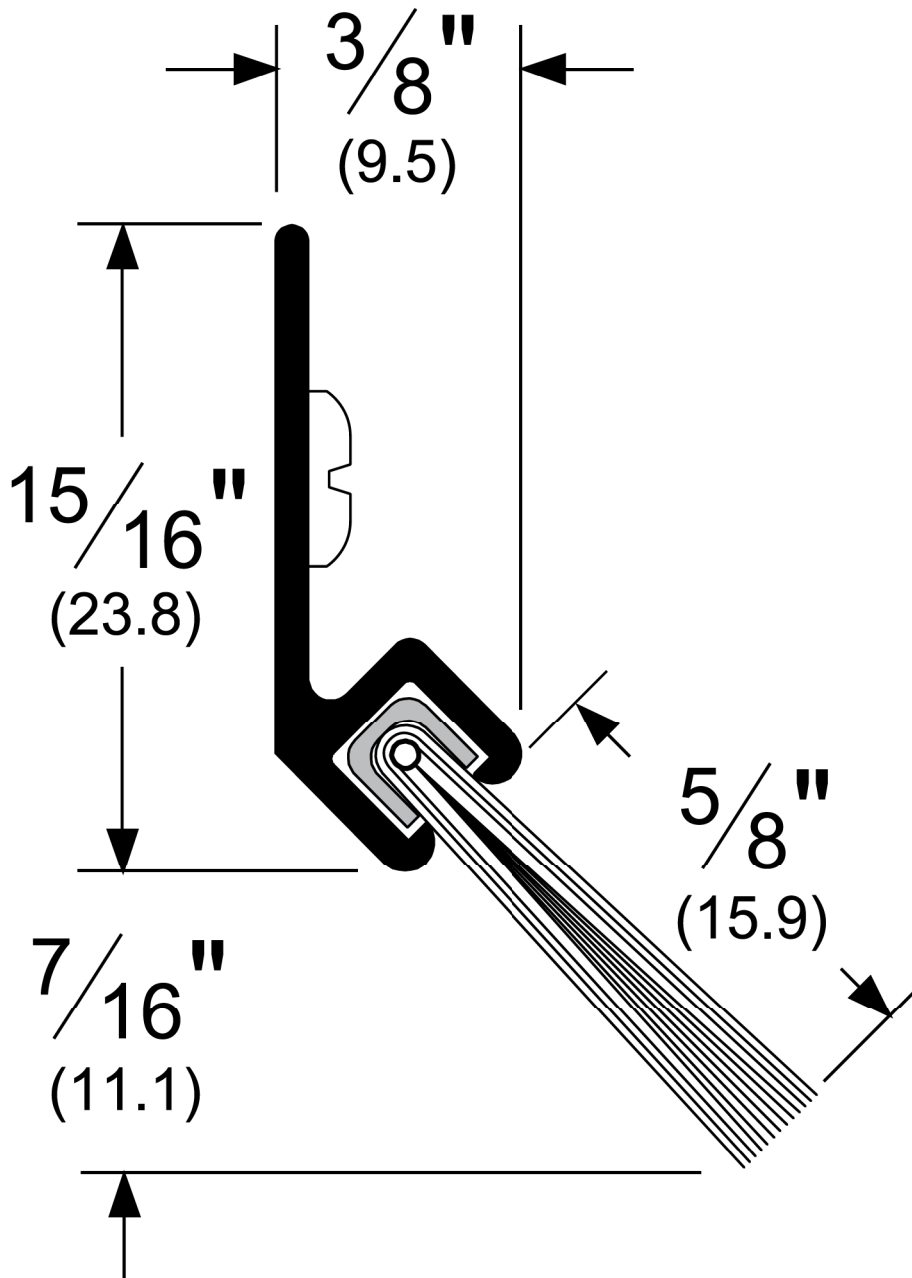

BHMA
CERTIFIED