

DP1

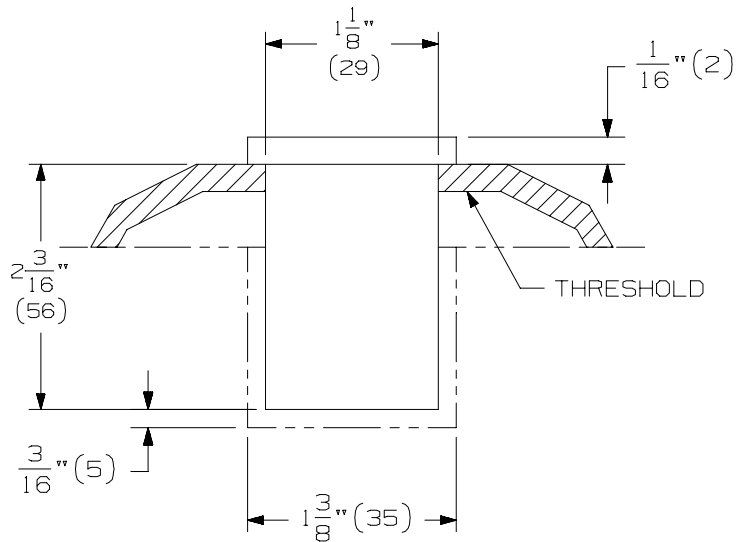
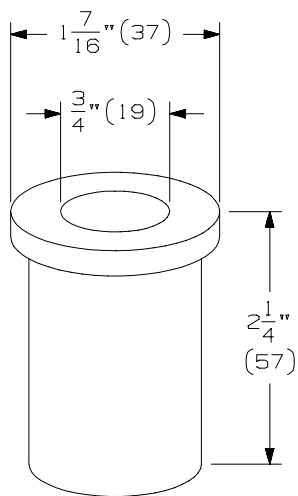

INSTRUCTIONS :

1. DRILL A $\varnothing 1\frac{3}{8}$ " (35) HOLE BY $2\frac{3}{8}$ " (60) DEEP FROM TOP OF THRESHOLD.
2. GROUT STRIKE INTO FLOOR.

DP2

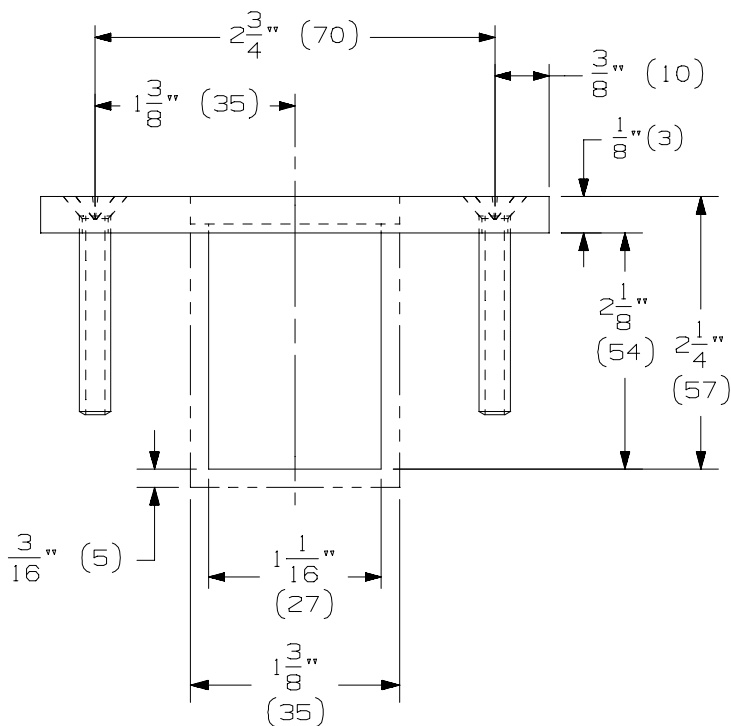
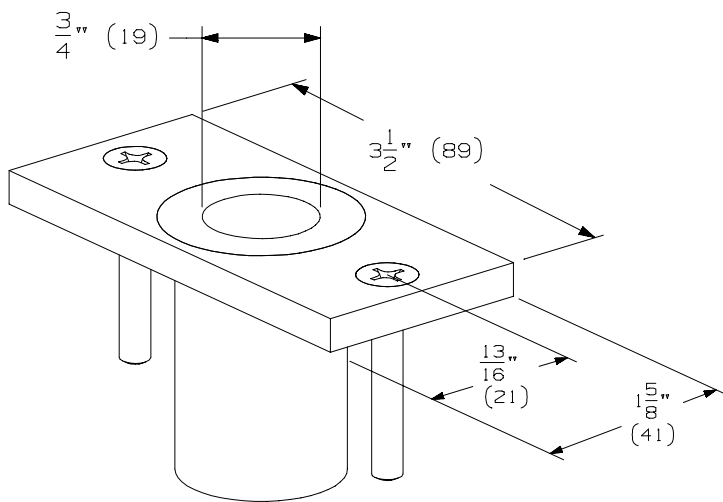

INSTRUCTIONS :

1. MORTISE PLATE INTO SURFACE.
2. DRILL A $\varnothing 1\frac{3}{4}$ " (35) HOLE BY $2\frac{5}{16}$ " (59) DEEP.
3. DRILL TWO $\varnothing \frac{5}{16}$ " (8) HOLES FOR PLASTIC ANCHORS.
4. PLACE PLASTIC ANCHORS IN HOLES.
5. GROUT STRIKE INTO FLOOR.
6. INSERT MOUNTING SCREWS.

QTY	SCREW DETAILS
2	12 X 1 1/2" FPHSMS
2	PLASTIC ANCHORS

IVES DP1 & DP2 DUST PROOF STRIKES
INSTALLATION TEMPLATE

IR Security & Safety®

NOTE: NOTE: DIMENSIONS IN () ARE MILLIMETERS.

TEMPLATE NUMBER: INST . DP _ 1

DATE: 11-08-02