

**Product selection guide**

LCN automatic operators are the proven standard in schools and health care facilities for over 20 years. They are easily retrofitted into existing doors and frames, as well as new construction. LCN low energy electrohydraulic and pneumatic automatic operators feature a heavy duty closer with a slow opening function. LCN's electromechanical automatic operators utilizes a motor gearbox and control box to perform the opening and closing function.

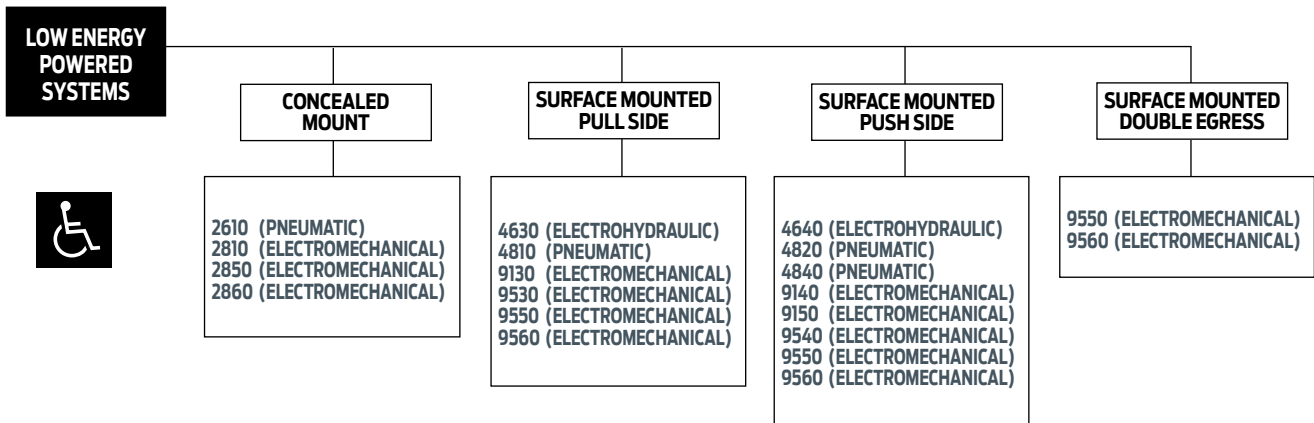

## Product comparison

### Electrohydraulic/Pneumatic Product Comparison

This chart shows a basic features comparison of the LCN electrohydraulic and pneumatic power operator systems designed to provide easy access without sacrificing closing power. Refer to the specific closer chapter for complete details.

| OPERATOR SERIES | MOUNTING             |                      |              |           | FINISH      |        | COVER   |       | CYLINDER   |           |                | *ARM FUNCTION  |           |            |                   |                  |                |              |             |
|-----------------|----------------------|----------------------|--------------|-----------|-------------|--------|---------|-------|------------|-----------|----------------|----------------|-----------|------------|-------------------|------------------|----------------|--------------|-------------|
|                 | TOP JAMB (PULL SIDE) | TOP JAMB (PUSH SIDE) | PARALLEL ARM | CONCEALED | POWDER COAT | PLATED | PLASTIC | METAL | NON-HANDED | NON-SIZED | ACCESSIBILITY* | POWER OPERATOR | HOLD-OPEN | DPS SWITCH | STANDARD (SINGLE) | REGULAR (DOUBLE) | EXTRA DUTY ARM | CUSH-IN-STOP | SPRING CUSH |
| 2610            | ○                    | ○                    | ○            | ●         | ●           | ●      | ○       | ●     | ○          | ○         | ♿              | ●              | ○         | ●          | 90°               | ○                | ○              | ○            | ○           |
| 4630            | ●                    | ○                    | ○            | ○         | ●           | ●      | ○       | ●     | ●          | ●         | ♿              | ●              | ●**       | ○          | 90°               | ○                | ○              | ○            | ○           |
| 4630CS          | ●                    | ○                    | ○            | ○         | ●           | ●      | ○       | ●     | ●          | ●         | ♿              | ●              | ●**       | ○          | 90°               | ○                | ○              | ○            | ○           |
| 4640            | ○                    | ●                    | ○            | ○         | ●           | ●      | ○       | ●     | ●          | ●         | ♿              | ●              | ●**       | ○          | ○                 | 90°              | ○              | ○            | ○           |
| 4640CS          | ○                    | ●                    | ○            | ○         | ●           | ●      | ○       | ●     | ●          | ●         | ♿              | ●              | ●**       | ○          | ○                 | 90°              | ○              | ○            | ○           |
| 4810            | ●                    | ○                    | ○            | ○         | ●           | ●      | ○       | ●     | ●          | ●         | ♿              | ●              | ○         | ○          | 90°               | ○                | ○              | ○            | ○           |
| 4820            | ○                    | ●                    | ○            | ○         | ●           | ●      | ○       | ●     | ●          | ●         | ♿              | ●              | ○         | ○          | ○                 | 90°              | ○              | ○            | ○           |
| 4840            | ○                    | ○                    | ●            | ○         | ●           | ●      | ○       | ●     | ●          | ●         | ♿              | ●              | ○         | ○          | ○                 | ○                | 90°            | 90°          | 90°         |

● AVAILABLE  
○ NOT AVAILABLE

♿ Meets ADA requirements (power mode).

\* See individual series for maximum manual opening.

\*\* Switch provided for continuous Hold Open (4630 & 4640 only).

## Product comparison

### Electromechanical Product Comparison

This chart shows a basic features comparison of the LCN electromechanical power operator systems designed to provide easy access without sacrificing closing power. Refer to the specific operator chapter for complete details.

| OPERATOR SERIES | MOUNTING                  |                                 |                                |                       |                             |                            | HANDING    |            | FINISH | COVER | ARM FUNCTION      |       |                         |                        |                           |
|-----------------|---------------------------|---------------------------------|--------------------------------|-----------------------|-----------------------------|----------------------------|------------|------------|--------|-------|-------------------|-------|-------------------------|------------------------|---------------------------|
|                 | SURFACE MOUNT SINGLE DOOR | SURFACE MOUNT SIMULTANEOUS PAIR | SURFACE MOUNT INDEPENDENT PAIR | CONCEALED SINGLE DOOR | CONCEALED SIMULTANEOUS PAIR | CONCEALED INDEPENDENT PAIR | HANDED**** | NON-HANDED |        |       | STANDARD ANODIZED | METAL | STANDARD (SINGLE LEVER) | REGULAR (DOUBLE LEVER) | DOUBLE EGRESS (PUSH/PULL) |
| 2810            | ○                         | ○                               | ○                              | ●                     | ○                           | ○                          | ●          | ○          | ○      | ○     | ○                 | ○     | ○                       | ○                      | ○                         |
| 2850            | ○                         | ○                               | ○                              | ○                     | ○                           | ○                          | ●          | ○          | ○      | ○     | ○                 | ○     | ○                       | ○                      | ○                         |
| 2860            | ○                         | ○                               | ○                              | ○                     | ○                           | ○                          | ●          | ○          | ○      | ○     | ○                 | ○     | ○                       | ○                      | ○                         |
| 9130            | ●                         | ○                               | ○                              | ○                     | ○                           | ○                          | ○          | ○          | ○      | ○     | ○                 | ○     | ○                       | ○                      | ○                         |
| 9140            | ●                         | ○                               | ○                              | ○                     | ○                           | ○                          | ○          | ○          | ○      | ○     | ○                 | ○     | ○                       | ○                      | ○                         |
| 9150            | ○                         | ●                               | ○                              | ○                     | ○                           | ○                          | ○          | ○          | ○      | ○     | ○                 | ○     | ○                       | ○                      | ○                         |
| 9530            | ●                         | ○                               | ○                              | ○                     | ○                           | ○                          | ○          | ○          | ○      | ○     | ○                 | ○     | ○                       | ○                      | ○                         |
| 9540            | ●                         | ○                               | ○                              | ○                     | ○                           | ○                          | ○          | ○          | ○      | ○     | ○                 | ○     | ○                       | ○                      | ○                         |
| 9550            | ○                         | ●                               | ○                              | ○                     | ○                           | ○                          | ○          | ○          | ○      | ○     | ○                 | ○     | ○                       | ○                      | ○                         |
| 9560            | ○                         | ○                               | ●                              | ○                     | ○                           | ○                          | ○          | ○          | ○      | ○     | ○                 | ○     | ○                       | ○                      | ○                         |

● AVAILABLE  
○ NOT AVAILABLE

\*\*\* All electromechanical operators open to 90°.

\*\*\*\* Handed for 2850 and 2860, double egress only.

## WHAT IS THE ADA?

The ADA is a civil rights law, not a building code. This act is designed to provide protection for people with disabilities. The law is divided into four major titles that prohibit discrimination against the disabled in Employment, Title I, Public Services and Transportation Title II, Public Accommodations Title III, and Telecommunications Title IV. Title III concerns doors and door controls.

## WHAT IS THE INTENT OF ADA, TITLE III?

Essentially, owners of certain types of buildings must remove barriers and provide people with disabilities with access equal to, or similar to, that available to the general public. The deadline for compliance was January 26, 1992.

The final rules implementing Title III were published in the Federal Register of July 26, 1991. To obtain a copy or ask questions, contact the U.S. DEPARTMENT OF JUSTICE. Technical information can be obtained from The U.S. ARCHITECTURAL AND TRANSPORTATION BARRIERS COMPLIANCE BOARD.

## HOW DOES ADA AFFECT DOORS?

The ADA defines an “accessible” opening which means, among other things, providing a door with a minimum 32” (813 mm) clear opening, easily manipulated handles, a maximum opening force, a minimum closing time, and capable of opening to at least 90°.

ADA criteria, based on OPENING FORCE, are similar to American National Standards Institute (ANSI) Standard A117.1. This is different from ANSI Standard A156.4, which is based on CLOSING FORCE.

### WHAT ARE THE OPENING FORCE LIMITS?

| DOOR TYPE               | OPENING FORCE     |
|-------------------------|-------------------|
| Fire Rated              | Note 1            |
| Interior Non-Fire-Rated | 5.0 lbs. (22.2 N) |
| Exterior Non-Fire-Rated | “Reserved”        |

*NOTE 1: All fire rated doors should have the minimum opening force allowable by the appropriate administrative authority, typically the local Fire Marshal. Closing and latching a fire door takes precedence over ADA opening force limits.*

## HOW IS THE DOOR MEASURED?

Two ADA criteria affect the door closer selection, adjustments, opening force, and time to close. Since the law does not clearly define the method of measurement, this is LCN's recommendation.

1. On the push side of the door, locate a point at the center line of the push plate/lock trim or 34” (864 mm), from the hinge edge of the door, whichever is greater.
2. Mark the floor at a point where the push side of the doors' latch stile is at 70°. Mark a second point where the push side is 3” (76 mm) from the latch.
3. Open the door so the latch is clear of the strike and the door is slightly off the stop.
4. Using a force gauge on the mark determined in Step #1, push the door open to the 70° mark established in Step #2. Observe the force readings. (Accuracy of the readings varies with the gauge quality.)
5. Adjust the closer spring power to meet the maximum opening force.
6. Hold the door at the 70° mark. Release the door and time the closing sweep between the two marks.
7. Adjust the closer main speed regulation valve to obtain a minimum 3 second “time to close”.

## FINISHES

- Available in six standard or a wide selection of optional custom powder coat finishes to blend with door and frame.
- LCN's powder coat finishes surpass 100 hours of salt spray which is over four times the ANSI standard for corrosion resistance.
- For installations where a higher level of corrosive resistance is required, LCN offers an optional special rust inhibiting (SRI) pre-treatment. Closers that combine the exclusive LCN powder coat finish and the SRI pre-treatment exceed the ANSI standard for corrosion resistance even further.
- Plated finishes are available as an option to accent door and frame.

*NOTE: Delayed action closers are not necessary to meet the ADA 3 second “time to close” requirement but do offer additional time for people to pass through the door.*

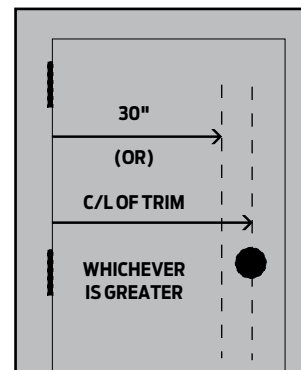
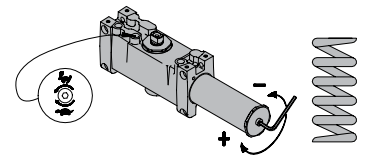

**CAUTION!** Any manual door closer, including those certified by BHMA to conform to ANSI Standard 156.4, that is selected, installed, and adjusted based on ADA requirements may not provide sufficient power to reliably close and latch a door. Auto Equalizer systems offer an alternate solution.

## WHAT ARE THE CHOICES FOR ADA COMPLIANT DOOR CONTROLS?

LCN offers both surface and concealed mountings for powered systems or manual closers.

### POWERED SYSTEMS

LCN Power Operator Systems offer easy access for the disabled and resolve the problem of obtaining reduced opening force while providing adequate closing force.

### POWERED SYSTEMS

Manual closers rely on reduced spring power to meet opening force requirements. Four principle factors affect the performance of manual closers:

#### 1. DOOR WIDTH:

A wider door provides more leverage for the user, thus reducing the opening force required.

#### 2. SPRING POWER:

Adjusting spring power to achieve a lower opening force also reduces the closing force available.

#### 3. ARM SELECTION:

The superior mechanical advantage of a regular arm system offers the user significantly lower average opening forces through the 70° measurement range compared to a standard arm (track type) closer. Regular arms also provide superior latching power.

#### REGULAR ARM

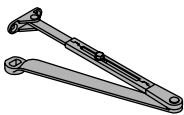

#### STANDARD ARM

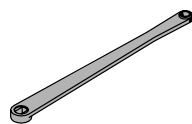

TYPICAL ARM POWER CURVE

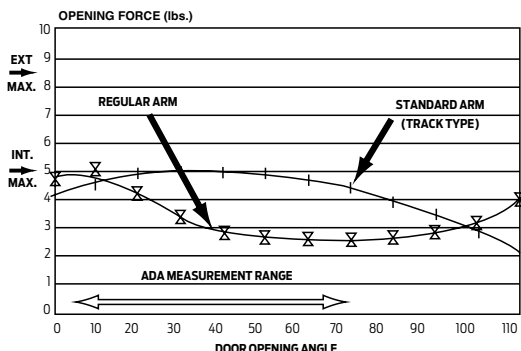

• "RESERVED", TYPICALLY 8.6 POUNDS

#### 4. ADDITIONAL FORCES

Improperly hung doors, stiff latches, HVAC or environmental pressures, and other forces acting on the door require increasing the closer spring power to reliably close and latch a door which produces a corresponding increase in opening force.

## INFORMATION SOURCES

LCN CLOSERS PHONE 877-671-7011  
 121 W. RAILROAD AVE. FAX 800-248-1460  
 P.O. BOX 100 www.securitiestechnologies.ingersollrand.com  
 PRINCETON, IL, USA 61356-0100

## U.S. DEPARTMENT OF JUSTICE

The Office of the Americans with Disabilities Act, Civil Rights Div.,  
 P.O. Box 66118, Washington, D.C. 20035-6118  
 (202) 514-0301

## THE U.S. ARCHITECTURAL AND TRANSPORTATION BARRIERS COMPLIANCE BOARD

1111 18th Street N.W., Suite 501, Washington, D.C. 20036  
 (800) 872-2253

## AMERICAN NATIONAL STANDARDS INSTITUTE

11 West 42nd Street, New York, N.Y. 10036  
 (212) 642-4900

- ANSI A117.1 Providing Accessibility and Usability for Physically Handicapped People
- ANSI A156.4 for Door Controls - Closers
- ANSI A156.19 Power Assist and Low Energy Power Operated Doors

## ELECTROHYDRAULIC & PNEUMATIC FASTENERS

Standard WOOD and MACHINE SCREW (WMS) pack contains phillips head wood and machine screws to install the closer. Thru Bolts (TB) and/or TORX® machine screws are available for all closers, except the 2610 series. LCN thru bolts can be installed on 1-3/4" thick doors with either the 1/4-20 machine screws or optional TORX security screws supplied with the closer. Optional sizes are available for 1-5/8" or 1-3/8" door thicknesses, but must be specified when ordering.

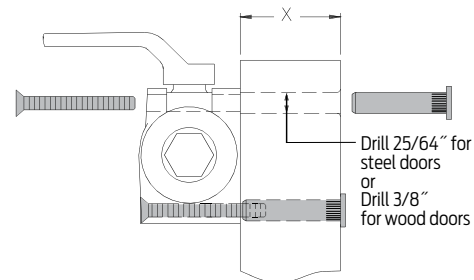

NOTE 1: Phillips head, metric machine screws are available, please specify.

## ELECTROMECHANICAL FASTENERS

Typically installed 1/4 - 20 machine screw for aluminum/steel frames. Wood screws included for wood door mounting. Consult factory for additional information.

## Low Energy Operators

The basic design concept for all LCN power operator systems is door control of both the opening and closing motion of the door. Our designs allow the system to be easily retrofitted into existing doors and frames as well as new construction. A basic LCN electrohydraulic/pneumatic system consists of a power operator based on a heavy duty LCN 4040 Series door closer and peripheral actuators. Our electromechanical automatic operators utilize a motor gearbox and a control box to perform the opening and closing function. LCN offers a choice of either electrohydraulic, electromechanical or pneumatic low energy automatic operators.

### APPLICATIONS

- Electrohydraulic and pneumatic systems are used primarily for manual opening with available push button automatic opening.
- Electromechanical systems are used primarily for automatic openings.
- For dedicated handicap access.
- Stand alone or integrated into larger multi-door systems.
- Surface and concealed mountings.
- Installation accessories available for unusual conditions.
- **CAUTION!** For exterior doors exceeding 3'0" wide by 7'0" tall, interior doors exceeding 4'0" wide by 8'0" tall, or any door exceeding 225 pounds, consult factory before specifying or installing LCN electrohydraulic or pneumatic automatic operators.
- **CAUTION!** For exterior doors exceeding 4'0" wide by 7'0" tall, interior doors exceeding 4'0" wide by 8'0" tall, or any door exceeding 200 pounds, consult factory before specifying or installing LCN Electromechanical automatic operators.

### A156.19 SYSTEM DESIGN PARAMETERS

- Cycle test standard of 300,000 full load operating cycles.
- Power opening plus full door control.
- Open to backcheck no faster than 3 seconds.
- Opening time to fully open is no faster than 4 seconds.
- Remain fully open for at least 5 seconds.
- Closing time from 90° to 10° is no faster than 3 seconds.
- Less than 15 lb to stop doors motion.
- Kinetic energy must not exceed 1.25 lb-ft.
- In event of failure, less than 15 lb to release latch, less than 30 lb to put door in motion, less than 15 lb to fully open door system.

### COMMON SYSTEM FEATURES

- Power opening plus full door control.
- No guide rails or safety devices required due to low energy design.
- Adjustable opening force.
- Adjustable closing power.
- 4630 and 4810 operators meet ADA reduced manual opening force requirements.
- Electrohydraulic and pneumatic systems feature adjustable backcheck that slows opening swing at about 70°.
- Electromechanical systems feature electronic backcheck that slows opening swing at about 70°.
- Systems allow for separate adjustment of general closing and latch speed.
- Electrohydraulic and pneumatic systems are available in six standard finishes or a wide selection of optional custom powder coat finishes to blend with door and frame.
- Electromechanical systems are available in two standard anodized finishes.
- UL & NEC compliant.
- Compatible with most security and safety systems.
- Capable of full integration with high security keypads and card readers.
- Wiring allows for sequential operation for vestibule applications. Electromechanical systems require additional components.
- Modular design simplifies installation and maintenance.

### WARRANTY

- 2 year limited warranty. See General Information Section for complete details.

### MAINTENANCE

- Operators mounted according to the LCN installation instructions require no periodic maintenance or adjustments.
- Periodic visual inspections are recommended.

## PNEUMATIC (AIR) POWERED SYSTEMS

LCN Pneumatic Auto Equalizer systems use the power of pressurized air to do the work of automatically opening the door. These systems have exceeded 3 million full load automatic operating cycles; that's 10 times the industry standard! A basic pneumatic system consists of an automatic operator to provide the door control, a control box that contains the valves and electrical timing circuits, actuators to start the system, and a compressed air source.

### UNIQUE FEATURES

#### ■ Multi-Door & Single-Door Solutions

The pneumatic automatic operators are ideal for multidoor applications because the cost per door leaf decreases significantly as the number of door leaves increase. A single control box may power up to two pairs of doors simultaneously making it a cost-effective solution for single or multi-door applications. This flexibility results in significant savings in material and installation costs.

#### ■ Quiet Operation

Since the pneumatic automatic operators are powered by pressurized air, they are quiet, efficient, and very reliable. Flexible LCN pneumatic tubing is the only connection between the control box and the door frame. There is no need for high-voltage wiring at the door frame since all of the power for operation is generated by pressurized air located away from the door frame. (Note: special fittings are available so 3/16" metal tubing (by others) can be used in fire rated plenums).

#### ■ Pneumatically (Air) Powered

All pneumatic automatic operators require a compressed air source. LCN's pneumatic systems have the flexibility to run as an independent unit (7980 Series has a compressor built into the control box) or to run off an existing air supply (7900 Series has connections for utilizing existing air supply). Using a self-contained 7980 Series control box for single or double door leaf applications eliminates the need for an independent compressor. Existing building air compressors with a storage tank can be used to reduce the cost of multi-door systems and must utilize the 7900 Series control boxes.

#### ■ Easy Adjustment/Installation

The air pressure and timing cycle are easily adjustable to meet the need of a specific installation. Because the control box can be located anywhere within 100 linear tubing feet from the controlled door for the 7900 Series or within 50 linear tubing feet for the 7980 Series, they can be placed in easily accessible locations. Convenient features such as sequential operation of vestibule doors are available.

#### ■ Multiple Mounting Configurations

Available in three different mounting configurations:

- Concealed in the frame (2610 Series).
- Top Jamb Surface Mounted on the pull side of the door (4810 Series).
- Top Jamb Surface Mounted on the push side of the door (4820 Series).
- Door Mounted, Parallel Arm on the push side of the door (4840 Series).

#### ■ Hazardous Location Use

Since there is no high-voltage wiring at the door frame, pneumatically powered systems are ideal for use in hazardous areas. The control box, which contain the valves and electrical timing circuits, is remotely located outside the hazardous area.

#### ■ Blow-Open (Smoke Evacuations Systems)

An auxiliary "blow-open" box is available and is controlled by the building smoke evacuation system to allow fresh air into the building. When activated, the normal pneumatic power operator functions are not available. The 7949 Series "blowopen" box works with or without the 7900 Series control boxes. (Limited to 50 linear foot of tubing).

### STANDARDS, LISTINGS & APPROVALS

- UL listed for self-closing doors without hold open under "SWINGING DOOR CLOSERS (GVEV)" file R1943.
- Tested and certified under ANSI Standard A156.19. Refer to Section 2.1 and consult factory for details.
- ANSI Standard A117.1, Section 4.13.13.
- ADA law, Section 4.13.12.
- UL 10B and UL 10C listing.
- Consult the factory for other listings

### WARRANTY

- 2 year limited warranty. See General Information Section for complete details.

### STANDARDS, LISTINGS & APPROVALS

- Operators mounted according to the LCN installation instructions require no periodic maintenance or adjustments.
- Periodic visual inspections are recommended.
- Inspect and service filter assembly in 7900 Series control boxes as required.
- No service contracts.

# Typical Pneumatic Powered Systems

These pages illustrate examples of typical Pneumatic LCN systems. Please consult your local SSC representative or LCN for assistance with specific installations and material requirements.

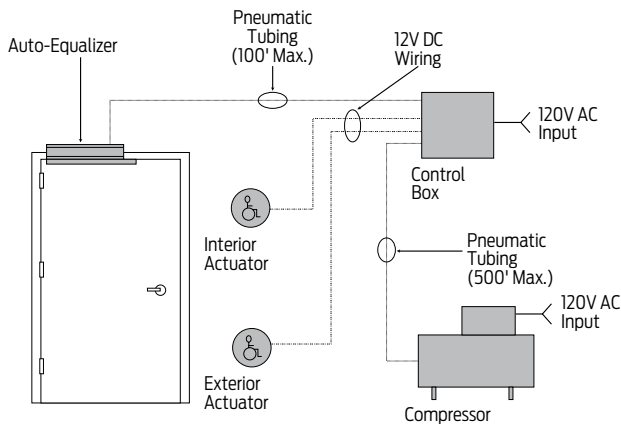

## SINGLE INTERIOR DOOR SYSTEM (WIRED)

- Slow opening interior door leaf
- System may be expanded to include an additional simultaneous door
- No guide rails or safety devices

### How It Works:

- A person requiring assistance triggers the system using either actuator.
- The control box supplies pressurized air to the Auto Equalizer which opens the door slowly to 90°, holds it for up to 30 seconds, then applies full spring power to reliably close and latch the door
- If not actuated, the Auto Equalizer functions as a full featured door closer

| Bill Of Materials: | Qty.        | Part No. | Description         |
|--------------------|-------------|----------|---------------------|
|                    | 1           | 4811     | Auto Equalizer      |
|                    | 1           | 8310-856 | Actuator (exterior) |
|                    | 1           | 8310-856 | Actuator (interior) |
|                    | 1           | 7901     | Control Box         |
|                    | 1           |          | Compressor*         |
|                    | (as needed) | 925      | Tubing              |

\*Contact Technical Support to verify compressor requirements.

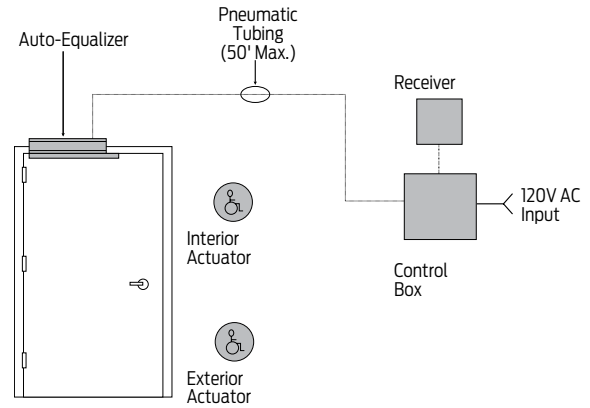

## SINGLE INTERIOR DOOR SYSTEM (WIRELESS)

- Slow opening automatic door on door leaf
- Wireless actuators
- Stand alone system, no planned expansion
- No guide rails or safety devices

### How It Works:

- A person requiring assistance triggers the system using either actuator
- The wireless transmitter in the actuator sends a signal to the wireless receiver which triggers the control box
- The control box supplies pressurized air to the Auto Equalizer which slowly swings door to 90°, holds it for up to 30 seconds, then applies full spring power to reliably close and latch the door.
- If not actuated, the Auto Equalizer functions as a full featured door closer

| Bill Of Materials: | Qty.        | Part No.    | Description       |
|--------------------|-------------|-------------|-------------------|
|                    | 1           | 4811        | Auto Equalizer    |
|                    | 2           | 8310-3856WS | Wireless Actuator |
|                    | 1           | 8310-865    | Wireless Receiver |
|                    | 1           | 7981        | Control Box       |
|                    | (as needed) | 925         | Tubing            |

These pages illustrate examples of typical Pneumatic LCN systems. Please consult your local SSC representative or LCN for assistance with specific installations and material requirements.

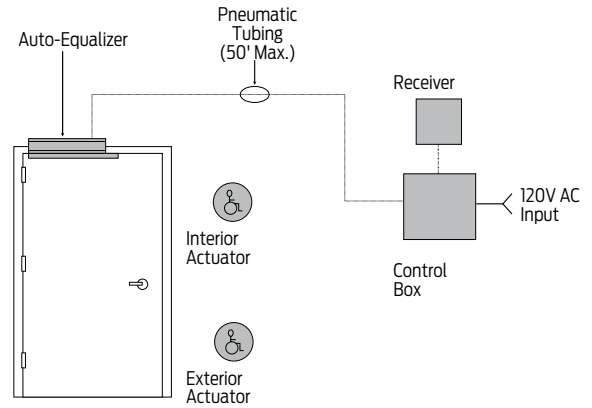
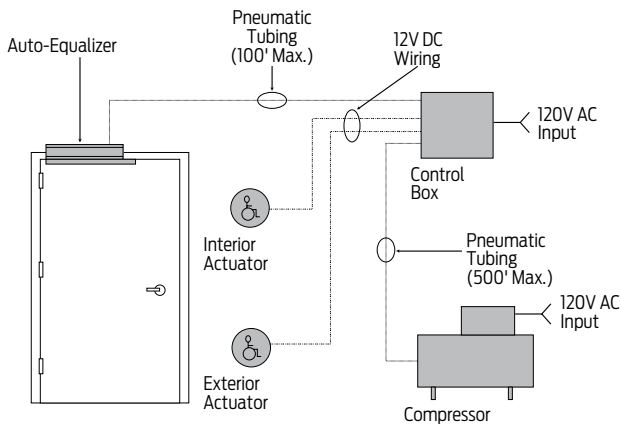

### ALTERNATE VESTIBULE DOOR SYSTEM (WIRED)

- Slow opening automatic doors with sequential operation for exterior and vestibule pairs of doors
- No guide rails or safety devices

#### How It Works:

- People requiring assistance press exterior actuator for entry
- The exterior pair opens and after a short sequential delay the interior pair opens
- As the system times out, first the exterior, then the interior doors close
- Pressing the interior actuator reverses the process to exit the building
- This allows passage through the vestibule without all doors open for the entire cycle
- If a person stops in the vestibule and the system times out before they exit, pressing either vestibule actuator opens the appropriate doors
- Compressor is sized for multiple systems. Sequential operation is not recommended with scanners or motion sensors
- If not actuated, the Auto Equalizer functions as a full featured door closer

| Bill Of Materials: | Qty.        | Part No. | Description                     |
|--------------------|-------------|----------|---------------------------------|
|                    | 2           | 4822     | Auto Equalizer (exterior)       |
|                    | 2           | 4811     | Auto Equalizer (interior)       |
|                    | 1           | 7902S    | Control Box with Sequencer Card |
|                    | 1           |          | Compressor*                     |
|                    | 4           | 8310-856 | Actuator                        |
|                    | (as needed) | 925      | Tubing                          |

### VESTIBULE DOOR SYSTEM (WIRELESS)

- Slow opening automatic doors with sequential operation for single exterior and vestibule doors
- No guide rails or safety devices

#### How It Works:

- People requiring assistance press exterior actuator for entry
- The exterior door opens and after a short delay the interior door opens
- When the system times out, first the exterior, then the interior doors close
- Pressing the interior actuator reverses the process to exit the building
- This allows passage through the vestibule without both doors open for the entire cycle
- If a person stops in the vestibule and the system times out before they exit, pressing either vestibule actuator opens the appropriate door
- Sequential operation is not recommended with scanners or motion sensors
- If not actuated, the Auto Equalizer functions as a full featured door closer

| Bill Of Materials: | Qty.        | Part No.    | Description                     |
|--------------------|-------------|-------------|---------------------------------|
|                    | 1           | 4822        | Auto Equalizer (exterior)       |
|                    | 1           | 4811        | Auto Equalizer (interior)       |
|                    | 1           | 7982S       | Control Box with Sequencer Card |
|                    | 4           | 8310-3856WS | RF Actuators                    |
|                    | 2           | 8310-865    | RF Receiver                     |
|                    | (as needed) | 925         | Tubing                          |

\* Contact Technical Support to verify compressor requirements.



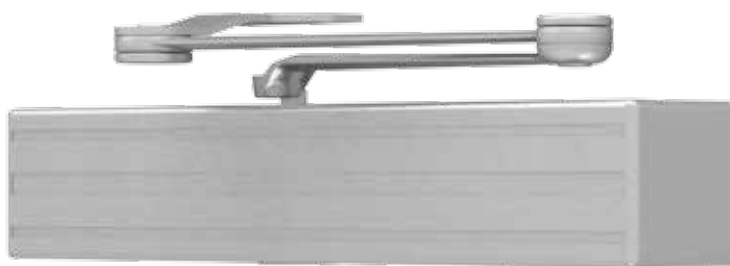

The 4840 AUTO EQUALIZER™ is LCN's pneumatically powered MULTIDOOR solution. This low-energy automatic operator provides easy access for people with disabilities, or the elderly. Designed primarily for manual opening applications that occasionally require automatic opening.

|                          |   |   |  |
|--------------------------|---|---|--|
| <b>Certifications</b>    | Grade 1 - ANSI A117.1, A156.19, UL 10C 228, ADA, 100 Hour Salt Spray, Meets BAA - Buy American Act  | <b>Cover</b>                            | Metal, standard  |
| <b>Body Construction</b> | <ul style="list-style-type: none"> <li>■ Cast Iron Body</li> <li>■ Full Complement Bearing</li> <li>■ 1-1/2" Diameter Piston</li> <li>■ 3/4" Diameter Double Heat Treated Pinion Journal</li> </ul> | <b>Fasteners</b>                        | Wood and machine screws<br>Specify door thickness if over 1-3/4"   |
| <b>Fluid</b>             | All Weather Fluid   | <b>Mounting</b>                         | Parallel arm (Push Side)   |
| <b>Handing</b>           | Non-Handed  | <b>Arms</b>                             | Extra heavy duty, standard<br>Cush-n-stop and spring cush, optional  |
| <b>Size</b>              | Adjustable Spring Size 1-5  | <b>Finishes/Colors/<br/>Powder Coat</b> | <ul style="list-style-type: none"> <li>■ Aluminum (689)</li> <li>■ Statuary Bronze (690)</li> <li>■ Light Bronze (691)</li> <li>■ Black (693)</li> <li>■ Dark Bronze (695)</li> <li>■ Brass (696)</li> <li>■ Custom colors optional</li> </ul> |
| <b>Warranty</b>          | 2 years   |   | <ul style="list-style-type: none"> <li>■ Optional SRI primer - powder coat only</li> <li>■ Optional plated finishes*</li> </ul> <p><i>*End caps are black</i></p>  |

**Special  
Templates**

Customized installation templates or products may be available to solve unusual applications. Contact LCN Product Support for assistance.

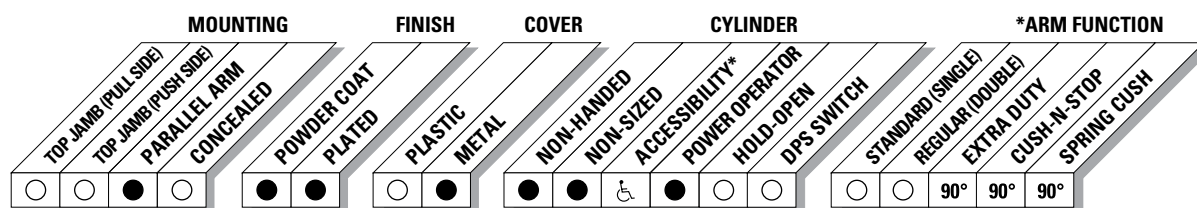

● AVAILABLE  
○ NOT AVAILABLE

♿ Meets ADA requirements (power mode).  
\* See individual series for maximum manual opening.

# 4840 Series Auto Equalizer

## Mounting details

### Parallel Arm (Push Side) Mounting

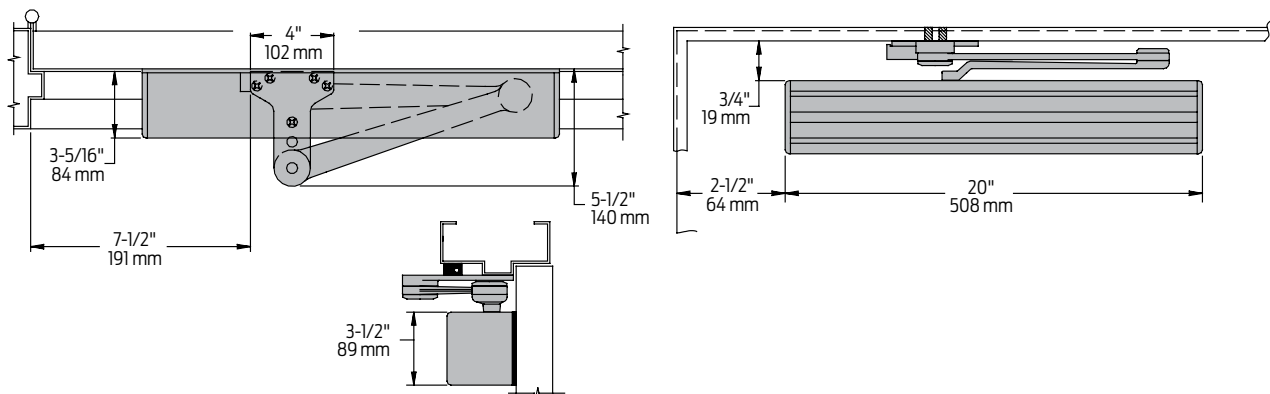

|                        |   |
|------------------------|---|
| <b>Butt Hinges</b>     | Should not exceed 5" (127 mm) in width  |
| <b>Auxiliary Stop</b>  | Recommended when CUSH-N-STOP or SPRING CUSH arms are not used   |
| <b>Clearance</b>       | EDA or CUSH shoes is 5-1/2" (140 mm) from door face   |
| <b>Top Rail</b>        | Minimum 4-1/8" (105 mm). 6" minimum top rail for screw not to show in glass   |
| <b>Head Frame</b>      | (Flush) requires PA SHOE ADAPTER, 4840-419  |
| <b>Stop Width</b>      | Minimum 1" (25 mm)  |
| <b>Blade Stop</b>      | Clearance requires 1/2" (13 mm) BLADE STOP SPACER, 4840-61  |
| <b>System Diagram</b>  | See "AUTOMATIC OPERATORS" section pages 7-8 for typical system wiring, and pages 28-29 for electrical and pneumatic data for control boxes  |
| <b>Maximum Opening</b> | <ul style="list-style-type: none"> <li>■ Maximum power opening is 90° with all arms</li> <li>■ Maximum manual opening is 105° with EDA or SPRING CUSH arms</li> <li>■ Maximum manual opening is 100° with CUSH-N-STOP arm</li> </ul> <p><i>NOTE: For CUSH-N-STOP or SPRING CUSH arm installations with maximum opening less than listed above, consult factory for Special Template</i></p> |

#### Notes:

- Multi-door solution utilizing 10,000,000 cycle heavy duty door closer
- Requires control boxes with integral compressor and control box using auxiliary air supply
- See CONTROL BOX pages 28-29 and actuators and accessories, pages 115-131
- Guard rails/safety mats not required

**Cylinders**



**4841-3971**  
Cast Iron Cylinder Assembly

- Non-handed
- Standard



**4841-3071**  
Cast Iron Cylinder Assembly

- Non-handed
- Mounting plate
- Standard

**Cover**



**4840-72MC**  
Metal Cover

- Non-handed
- With black end caps
- Standard

**Arms**



**4840-3077EDA**  
Extra Duty Arm

- Non-handed
- Features forged solid steel main arm and forearm for potentially abusive installations
- Standard



**4840-3077CNS**  
Cush-n-Stop Arm

- Non-handed
- Features forged solid steel main arm and forearm with stop in soffit shoe
- Optional



**4840-3077SCNS**  
Spring CUSH Arm

- Non-handed
- For abusive applications features forged solid steel main arm and forearm with spring loaded stop in soffit shoe
- Optional

**Installation accessories**



**4840-30  
CUSH Shoe Support**

- Provides anchorage for fifth screw used with EDA and CUSH arms, where reveal is less than 3-1/16" (78 mm)



**4840-61  
Blade Stop Spacer**

- Required to lower parallel arm shoe to clear 1/2" (13 mm) blade stop



**4840-419  
PA Flush Panel Adapter**

- Provides horizontal mounting surface for parallel arm shoe on single rabbeted or flush frame

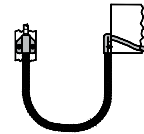

**4840-459  
Door Loop Kit**

- Surface mounted, flexible metal loop transfers pressurized air via pneumatic tubing from frame to closer end cap
- Extra caps allow tubing to run on frame surface or concealed in the frame.

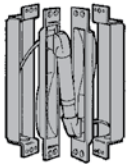

**4840-460  
Pneumatic Transfer Hinge**

- Transfers pressurized air via pneumatic tubing from frame to door leaf for fully concealed installations
- Preparation of a raceway is required from the hinge stile of the door to the top rail for concealment of the pneumatic tubing within the door leaf

### How-to-order 4840 Series closers

#### Specify finish

- Standard Powder Coat \_\_\_\_\_  
Aluminum, Dark Bronze, Statuary, Light Bronze, Black, Brass

### Closer options

#### Finishes

- Custom Powder Coat (RAL) \_\_\_\_\_
- Plated Finish, US \_\_\_\_\_

#### Arm

- CUSH-N-STOP (CUSH)
- SPRING CUSH (SCUSH)

#### Screw pack

- TB\*, Wood & Machine Screw (TBWMS)  
\*Specify door thickness if other than 1-3/4".

#### Installation accessories

- Cush Shoe Support, 4840-30
- Blade Stop Spacer, 4840-61
- PA Flush Panel Adapter, 4840-419
- Door Loop Kit, 4840-459
- Pneumatic Transfer Hinge, 4840-460

#### Special template

- ST- \_\_\_\_\_

#### Closer will be shipped with:

- Standard cylinder
- Standard metal cover
- Extra duty arm
- Wood and machine screw pack  
unless options listed below are selected

### Table of sizes

- Non-sized 4841 cylinder is adjustable from size 1 through size 5 and is shipped set to size 3
- Closing power of 4841 closers may be increased 50%

#### Exterior (and Vestibule) door width

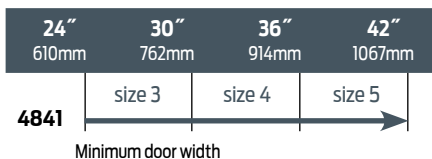

#### Interior door width

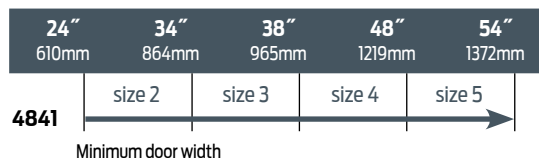

Indicates recommended range of door width for closer size.